

Circuit Breaker Enclosure



9

Busway (Low Voltage)

Product Description	V12-T9-2
Product History	V12-T9-2
Product History Time Line	V12-T9-3
Replacement Capabilities	V12-T9-4
Plug-In Units	V12-T9-4
Vintage Busway Products	V12-T9-4
100 Ampere Busway	V12-T9-6
Standard Plug-In Busway	V12-T9-7
Standard and Low Impedance	V12-T9-8
Quick-Assembled Plugs	V12-T9-10
CP2, CP3 or CP4 SAFETYBUS Busway Plug-In Units	V12-T9-11
Technology Upgrades	V12-T9-14
Clipper Power Systems, Busway TVSS Protection	V12-T9-14
IQ Energy Sentinel for Bus Plugs	V12-T9-15
Further Information	V12-T9-15
Pricing Information	V12-T9-15

Busway (Low Voltage)

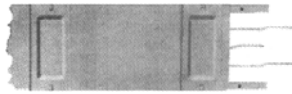

Standard Plug-In

Product Description

Eaton's Cutler-Hammer® low voltage busway consists of aluminum or copper bars inside a metal housing used for power distribution. Busway is available in ampere ratings of 100–5000A. Busway is available as feeder (indoor or outdoor) and plug-in. Feeder busway routes power from point-to-point, whereas plug-in busway allows for power to be tapped off along a run as needed. Busway is typically used in manufacturing buildings and high-rise office buildings.

Product History

Westinghouse began marketing low voltage busway in 1938. The first product offering was power distribution busway, using a multiple bolt joint that later evolved into standard plug-in busway. Victory bus duct was developed during the Second World War to comply with federal limitations placed on usage of materials such as steel and copper, which were critical to the war effort. In 1947, Westinghouse began manufacturing busway at the newly acquired facility in Beaver, PA, with standard

plug-in and feeder bus in ratings up to 1500A. All of these early designs used separated, uninsulated busbars inside a totally enclosed or perforated steel housing.

In 1951, low impedance feeder busway was introduced as the first design to use heat-shrinkable tubing for insulation on the busbars and a ventilated steel housing. An internal ground bus was not available with this product line, but provisions were made for mounting an external ground bus directly to the busway housing. Low impedance feeder and standard plug-in busway accounted for the majority of busway business written by Westinghouse through the 1950s and into the 1960s. Low impedance plug-in busway was introduced in 1961. With this design, the product offering was expanded to a maximum of 5000A for feeder and 4000A for plug-in.

During the 1950s, various other designs were introduced to meet specific customer needs. Westinghouse Lifeline Unibus, rolled out in 1955, provided low impedance characteristics with plug-in openings and incorporated flexible armored cable into the design for use as elbows, offsets and flat to edgewise adapters.

Westinghouse high frequency busway was introduced in 1958 to address the inherent problems of transmitting power at frequencies from 180 to 20,000 Hz. Cutler-Hammer high frequency BV (balanced voltage) busway was also marketed during the late 1950s and early 1960s. Westinghouse high frequency busway and Cutler-Hammer BV busway both found success in aircraft manufacturing plants, industrial induction heating systems, military missiles and radar bases.

Electric utility busway was also introduced by Westinghouse in 1958 and was designed to conduct direct current with low voltage drop. By 1963, electric utility busway had been expanded to meet the growing industrial market for direct current power and was marketed simply as DC busway. This product line was applied to feeding plating processes, welding installations, mill drives and motors.

In 1958, Westinghouse sold the rights to the Life Line Unibus product line to EDP of Allentown, PA, which marketed EDP Unibus until 1962 when EDP became a wholly owned subsidiary of Eaton. Eaton successfully marketed Unibus until the product line was discontinued in 1974.

In 1966, Westinghouse introduced its first true sandwich bus design with H5000 feeder busway. H5000 was also the first single bolt joint design offered by Westinghouse and it initially used a PVC shrink tubing and later a Mylar® wrap for busbar insulation. A combination of steel and aluminum channels were used to form a lightweight non-magnetic housing. The grounding method for H5000 was similar to low impedance busway and an external ground bus mounted onto the housing was the only offering. H5000 plug-in busway rolled out in 1968 as a non-sandwich design with separated and uninsulated busbars.

In 1970, the Eaton's Cutler-Hammer Bethlehem, PA, plant introduced CP2 SAFETYBUS that used an innovative single bolt, bridge joint design with a steel housing for plug-in, and a combination of steel and aluminum channels for the feeder housing. CP2 used a Mylar wrap for busbar insulation and an Alstan® process for plating. The feeder busway was a sandwich design while the plug-in design used separated busbars that were braced and supported by corrugations formed in the housing sides.

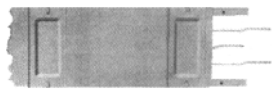

Standard Plug-In

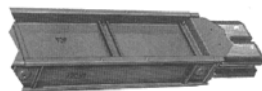

H5000 Feeder

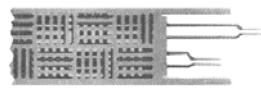

Electric Utility (DC)

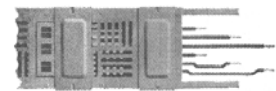

Low Impedance Plug-In

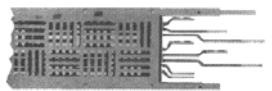

Low Impedance Feeder

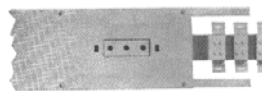

High Frequency



H5000 Plug-In 225–1000A

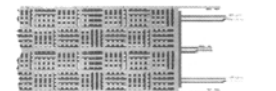

Current Limiting



Typical Pow-R-Way Plug-In Straight Length



Typical Pow-R-Way II Plug-In Straight Length

Westinghouse introduced the Pow-R-Way product line in 1971. Pow-R-Way employed the sandwich design in both feeder and plug-in. At that time, Pow-R-Way used a combination of PVC, applied by the fluidized bed process, and Mylar sheeting for busbar insulation that achieved a Class A, 105°C rating. Silver-plating of all joint and contact surfaces was applied by a Zincate process. Pow-R-Way is a bolt-end/slot-end design with a single bolt connection at the joint and is rated from 600 to 5000A. Pow-R-Way II was rolled out in 1975 with ratings of 225A and 400A in feeder and plug-in. Pow-R-Way II is a single, captive bolt per bar design for indoor, horizontal applications only.

During 1980, the Cutler-Hammer busway design was upgraded and they began marketing CP3 SAFETYBUS. CP3 featured an improved bridge joint package and a polyethylene terephthalate wrap for busbar insulation. CP3 maintained the CP2 housing design with busbar separation in the plug-in product configuration.

Cutler-Hammer CP4 SAFETYBUS was introduced in 1985 and incorporated the sandwich design into the plug-in busway. CP4 featured a UL® recognized case ground path rating and 130°C Mylar busbar insulation. CP4 used the CP3 bridge joint package and accepted CP2 and CP3 bus plugs. The CP4 product line was successful in both the commercial and industrial markets until it was discontinued in 1994.

In 1988, Westinghouse moved the busway product line to the Greenwood, SC, manufacturing facility. At that time, an improved Alstan plating process was implemented for silver-plating the joint and contact surfaces. In 1993, the automated fluidized bed process was changed to Class B, 130°C, epoxy insulation.

Cutler-Hammer Pow-R-Way III® was introduced in 1997. As in the past, specific customer needs have driven the design of this product line. High short-circuit ratings, finger-safe protection at the plug-in openings, integral housing ground path, two-piece extruded aluminum housing and an optional 200% neutral are just some of the features with this product line.

Product History Time Line

Product	1935	1940	1945	1950	1955	1960	1965	1970	1975	1980	1985	1990	1995	2000	Present
Power distribution bus															
Victory bus duct															
Standard plug-in															
Low impedance bus															
Life line Unibus															
High frequency bus															
Cutler-Hammer BV bus															
Current limiting bus															
Electric utility bus															
DC busway															
100 ampere busway															
Low impedance plug-in															
Cutler-Hammer Unibus															
H5000 feeder															
H5000 plug-in															
Cutler-Hammer CP2															
Pow-R-Way															
Pow-R-Way II															
Cutler-Hammer CP3															
Cutler-Hammer CP4															
Pow-R-Way III															

Replacement Capabilities

Plug-In Units

Replacement Capabilities

Busway Types	Bus	Adapter ^①	Plugs
Power distribution bus	No	No	No
Victory bus duct	No	No	No
Standard plug-in	Yes	No	Yes
Low impedance bus	No	Yes	—
Life line Unibus	No	No	No
High frequency bus	No	No	No
Cutler-Hammer BV bus	No	No	No
Current limiting bus	No	Yes	—
Electric utility bus	No	No	No
DC busway	No	No	No
100 ampere busway	Yes	No	Yes
Low impedance plug-in	No	Yes	Yes
Cutler-Hammer Unibus	No	No	No
H5000 feeder	No	No	—
H5000 plug-in	No	No	Yes
Cutler-Hammer CP2	No	Yes	Yes ^②
Pow-R-Way	Yes	No	Yes
Pow-R-Way II	Yes	No	Yes
Cutler-Hammer CP3	No	Yes	Yes ^②
Cutler-Hammer CP4	No	Yes	Yes ^②
Pow-R-Way III	Yes	—	Yes

Notes

^① Busway adapter (transposition) available from old line to Pow-R-Way III only.

^② Fusible units only. No breaker units available.

Vintage Busway Products

- Replacement pieces or additions to vintage Cutler-Hammer bus (CP2, CP3, CP4) are being handled whenever possible by making transition to Eaton's current design Pow-R-Way III bus
- Obtain style number and complete nameplate information from existing busway and contact your local Eaton Field Sales office for pricing and availability
- Plugs for vintage Cutler-Hammer bus, Pow-R-Way bus, and Pow-R-Way III bus are not interchangeable

Pow-R-Way Plug-In Unit

Stab base assembly for breaker and fusible types.

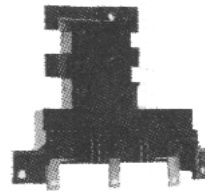

Top View

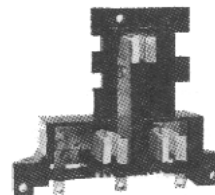

Bottom View

Vintage Busway Plug-In Unit

Stab base assembly for breaker and fusible types.

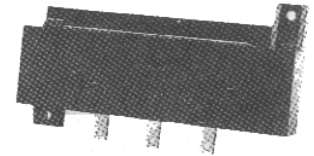

Top View

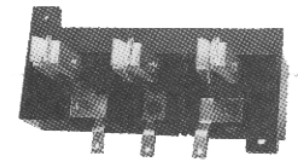

Bottom View

Fuse Base Assembly

For all busway.

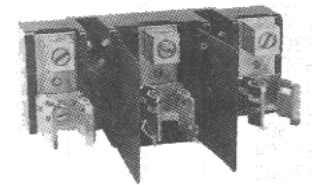

30A Maximum

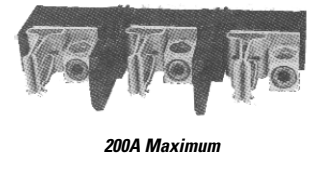

200A Maximum

Originally a Westinghouse Product

Breaker Plug-In Units

Reference Catalog Number for Existing Complete Plug-In Unit ^①	Replacement Stab Base Assembly
Pow-R-Way	
IBPFB	2528D04G01
IBPFBP	2528D04G01
IBPFCL	2528D04G01
IBPFD	2528D04G01
IBPJD	2528D04G12
IBPKB	2528D04G07
IBPKD	2554D03G06
IBPLAP	2532D45G06
IBPLB	2554D03G05
IBPLCL	2554D03G03
IBPMC	2537D17G03
IBPNBP	2537D17G07
Standard Plug-In and Low Impedance Busway ^②	
BPFB	2528D03G01
BPFBP	2528D03G01
BPFCCL	2528D03G01
BPFD	2528D03G01
BPJD	2528D03G10
BPKB	2528D03G07
BPKD	2537D20G06
BPLB	2537D20G05
BPLCL	2537D20G01
BPMC	374D017G03

Fusible Plug-In Units

Reference Catalog Number for Existing Complete Plug-In Unit ^①	Replacement Stab Base Assembly	Replacement Fuse Base
Pow-R-Way		
ITAP321	2528D04G02	5009D52G01
ITAP361	2528D04G02	5009D52G13
ITAP322	2528D04G02	5009D52G03
ITAP362	2528D04G02	5009D52G04
ITAP323	2528D04G02	5009D52G05
ITAP363	2528D04G02	5009D52G05
ITAP324	767A373G02	2532D78G01
ITAP364	767A373G02	2532D78G01
ITAP325	2554D03G03	627B426G02
ITAP365	2554D03G03	627B426G02
ITAP326	2554D03G02	627B426G04
ITAP366	2554D03G02	627B426G04
ITAP367	2554D03G01	2553D93G02
ITAP361H	2528D04G02	2535D92G09
ITAP362H	2528D04G02	2535D92G10
ITAP363H	2528D04G02	2535D92G11
ITAP364H	2568D13G09	2532D78G02
ITAP365H	2554D03G03	1205C02G02
ITAP366H	2554D03G02	2599D97G02
Standard Plug-In and Low Impedance Busway ^②		
TAP321	2528D03G02	5009D52G01
TAP361	2528D03G02	5009D52G13
TAP322	2528D03G02	5009D52G03
TAP362	2528D03G02	5009D52G04
TAP323	2528D03G02	5009D52G05
TAP363	2528D03G02	5009D52G05
TAP324	767A373G01	2532D78G01
TAP364	767A373G01	2532D78G01
TAP325	2537D20G04	627B426G02
TAP365	2537D20G04	627B426G02
TAP326	2584D73G01	627B426G04
TAP366	2584D73G01	627B426G02
TAP361H	2528D03G02	2535D92G09
TAP362H	2528D03G02	2535D92G10
TAP363H	2528D03G02	2535D92G11
TAP364H	767A373G01	2532D78G02
TAP365H	2537D20G04	1448D09G05
TAP366H	374D017G03	373D043G06

Notes

- ① Check Vista for pricing and minimum order quantities.
- ② Replacement stab base assembly and fuse base style numbers specified correspond to the most recent design of the reference catalog number for the complete plug-in unit. For verification that this style number is the correct replacement for your existing plug-in unit, contact your local Eaton Field Sales office.

100 Ampere Busway



Elbow, Busway and Cable Tap Box

100 Ampere Busway—Copper (Includes 50% Internal Ground Bar)

Description	Three-Phase, Three-Wire 600V Maximum Catalog Number	Three-Phase, Four-Wire FN 277/480V Catalog Number	Single-Phase, Three-Wire 120/240V Catalog Number
Straight Lengths			
10 ft (3048 mm)	CST13G	CST14G	CST13NG
5 ft (1524 mm)	CST135G	CST145G	CST13N5G
3 ft (914.4 mm)	CST133G	CST143G	CST13N3G
2 ft (609.6 mm)	CST132G	CST142G	CST13N2G
1 ft (304.8 mm)	CST131G	CST141G	CST13N1G
Elbows			
Forward	CFE13G	CFE14G	CFE13NG
Rearward	CRE13G	CRE14G	CRE13NG
Upward	CUE13G	CUE14G	CUE13NG
Downward	CDE13G	CDE14G	CDE13NG
Tees			
Forward	CFT13G	CFT14G	CFT13NG
Rearward	CRT13G	CRT14G	CRT13NG
Upward	CUT13G	CUT14G	CUT13NG
Downward	CDT13G	CDT14G	CDT13NG

Cable Tap Boxes

Description	Three-Wire or Four-Wire Catalog Number	Ground (If Required) Catalog Number
Plug-in	PIB14	PIGS100
End	EB14	GL100
Center	CBIB14G	(Included)

Fusible Plug-In Units

Voltage Rating	Ampere Rating	Fusible Enclosure Catalog Number	Ground (If Required) Catalog Number
240	30	FAN321	PIGS100
240	60	FAN322	PIGS100
240	100	FAN323	PIGS100
600	30	FAN361	PIGS100
600	60	FAN362	PIGS100
600	100	FAN363	PIGS100

Circuit Breaker Plug-In Units

Voltage Rating	Ampere Rating	Circuit Breaker Enclosure Catalog Number	Receptacle Enclosure Catalog Number	Ground (If Required) Catalog Number	External Handle (Required for Hook-Stick Operation) Catalog Number
QUICKLAG HQP	15–50	PINQP	LCNQP	PIGS100	HMQP
ED, EHD, FDB	15–100	PINFD	LCNFD	PIGS100	HMFD

Accessories

Item	Catalog Number
End closer	EC1
Outlet cover	OC1
Edgewise hanger	EH1
"C" clamp hanger	FH1
Slip-on wall flange	WF1

End Closers—EC1

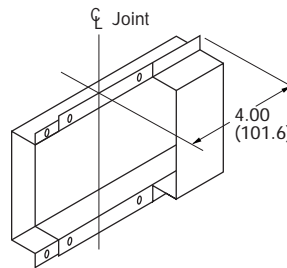

Replacement Outlet Cover—OC1

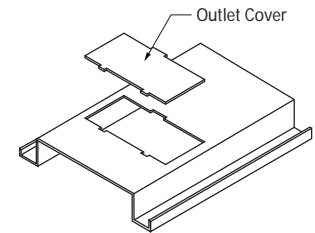

Standard Plug-In Busway Originally a Westinghouse Product

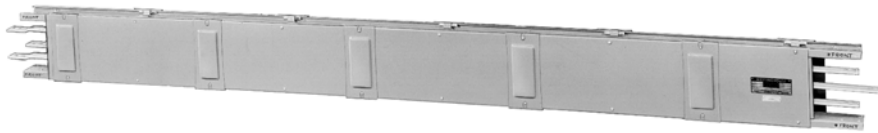

Typical Standard Plug-In Straight Length

Catalog Numbers

Ampere Rating	Catalog Number for 10-Foot Lengths ^②		Fittings (Price of Footage Through Each Fitting Must be Added)		
	Aluminum Catalog Number	Copper Catalog Number	Universal Cable Tap Box (Lugs Included) ^③ Catalog Number	End Closer Aluminum Catalog Number	Copper Catalog Number
Three-Phase, Three-Wire, 600V with 50% Ground Bus					
225	AST302G	ST302G	UCTB302G	UEC10	UEC10
400	AST304G	ST304G	UCTB304G	UEC20	UEC15
600	AST306G	ST306G	UCTB306G	UEC35	UEC20
800	AST308G	ST308G	UCTB308G	UEC50	UEC30
1000	AST310G	ST310G	UCTB310G	UEC60	UEC40
Three-Phase, Four-Wire, Full Neutral, 277/480V with 50% Ground Bus					
225	AST502G	ST502G	UCTB402G	UEC10	UEC10
400	AST504G	ST504G	UCTB404G	UEC20	UEC15
600	AST506G	ST506G	UCTB406G	UEC35	UEC20
800	AST508G	ST508G	UCTB408G	UEC50	UEC30
1000	AST510G	ST510G	UCTB410G	UEC60	UEC40

Cantilever Hangers

Ampere Rating	Aluminum Catalog Number	Copper Catalog Number
Three-Phase, Three-Wire, 600V		
225	CLH10	CLH10
400	CLH20	CLH15
600	CLH35	CLH20
800	CLH50	CLH30
1000	CLH60	CLH40
Three-Phase, Four-Wire, Full Neutral, 277/480V		
225	CLH10	CLH10
400	CLH20	CLH15
600	CLH35	CLH20
800	CLH50	CLH30
1000	CLH60	CLH40

Miscellaneous Accessories

Description
Wall/floor flange
Extra cantilever hangers
Hookstick kit (8–14 feet) HS8-14 ^④
Renewal Parts
Joint hardware—EXWK10
Access covers (two)
Splice plates (two)

Notes

- ^① When ordering from stock, all hangers must be shown as a separate item marked included in price.
- ^② Suitable for horizontal mounting only. Contact your local Eaton Field Sales office for pricing and lead times.
- ^③ If UCTB is used on end of run, an end closer must also be used for that end.
- ^④ Normally available from stock.

Standard and Low Impedance

Originally a Westinghouse Product

Circuit Breaker Plug-In Units



Circuit Breaker Plug-In Unit (Closed)

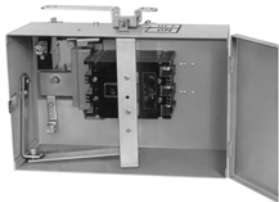

Circuit Breaker Plug-In Unit (Open)

The enclosure, circuit breaker, neutral and ground are ordered and shipped assembled.

Note: Breaker and fusible plugs must be ordered as assembled units. See **V12-T9-10** for instructions on how to build the assembled catalog numbers.

Note: For units mounting at the joint and feeder type ducts, see bolt-on units—standard plug-in, low impedance and H5000.

Circuit Breaker Selection and Interrupting Ratings

Breaker Frame	Ampere Rating	Symmetrical Amperes		
		240 Vac	480 Vac	600 Vac
EHD	15–60	18,000	14,000	—
	70–100	18,000	14,000	—
FDB	15–60	18,000	14,000	14,000
	70–100	18,000	14,000	14,000
	110–150	18,000	14,000	14,000
FD	15–60	65,000	25,000	18,000
	70–100	65,000	25,000	18,000
	110–150	65,000	25,000	18,000
HFD	15–60	100,000	65,000	25,000
	70–100	100,000	65,000	25,000
	110–150	100,000	65,000	25,000
FDC	15–60	200,000	100,000	50,000
	70–100	200,000	100,000	50,000
	110–150	200,000	100,000	50,000
JDB	70–225	65,000	25,000	18,000
	250	65,000	25,000	18,000
JD	70–225	65,000	25,000	18,000
	250	65,000	25,000	18,000
HJD	70–225	100,000	65,000	25,000
	250	100,000	65,000	25,000
JDC	70–225	200,000	100,000	50,000
	250	200,000	100,000	50,000
KDB	250–400	65,000	35,000	25,000
KD	250–400	65,000	35,000	25,000
HKD	250–400	100,000	65,000	35,000
KDC	250–400	200,000	100,000	50,000
LDB	300–600	65,000	45,000	25,000
LD	300–600	65,000	45,000	25,000
HLD	300–600	100,000	65,000	35,000
LDC	300–600	200,000	100,000	50,000
MDL	400–800	65,000	50,000	25,000
HMDL	400–800	100,000	65,000	35,000
NP	400–1200	65,000	50,000	25,000
HND	400–1200	100,000	65,000	35,000
FB (TRI-PAC®)	15–100A	200,000	200,000	200,000
	70–400	200,000	200,000	200,000
LA (TRI-PAC)	70–400	200,000	200,000	200,000
	70–400	200,000	200,000	200,000
NB (TRI-PAC)	600–800	200,000	200,000	200,000
	600–800	200,000	150,000	200,000

Notes

- ① Full neutral. For half neutral, contact your local Eaton Field Sales office.
- ② Not available for low impedance bus duct.
- ③ Normally available from stock.
- ④ Contact your local Eaton Field Sales office for delivery. Order by description on suffix **BUS**.
- ⑤ Obsolete; no longer available.

Catalog Numbers

Breaker Frame	Enclosure Catalog Number	Neutral (If Required) ①		Ground (If Required) ②
		Standard Plug-In Catalog Number	Low Impedance Catalog Number	
EHD, FDB, FD, HFD, FDC (15–150A)	BPFD ③	N110 (15–110A) ③ N250KB (125–150A) ③	ZN110 (15–110A) ③ ZN250KB (125–150A)	GS104 ③
JDB, JD, HJD, JDC (70–250A)	BPJD ③	N250KB (125–250A) ③	ZN250KB (125–250A) ③	GS104 ③
KDB, KD, HKD, KDC (125–400A)	BPKD	N400 (250–400A) ③	ZN400 (250–400A) ③	GS104 ③
LDB, LD, HLD, LDC (300–600A)	BPLD	④	④	④
MC, HMC (500–800A)	BPMD	N/A	④	④
NC, HNC (900–1200A)	BPND	④	④	④
FB (TRI-PAC®) (15–100A)	BPFBP	N110 (15–100A) ③	ZN110 (15–100A)	GS104 ③
LA (TRI-PAC) (125–400A)	BPLAP ⑤	N400 (125–400A) ③	ZN400 (125–400A) ③	GS104 ③
NB (TRI-PAC) (500–800A)	BPBPNB	④	④	GS104 ③

Replacement Capabilities—Standard and Low Impedance

Originally a Westinghouse Product

Fusible Plug-In Units

- For standard plug-in and low impedance plug-in busway (not for use on Pow-R-Way busway. Not available for low impedance bus duct)
- Fuses not included
- Mechanical lugs only
- Plug-in unit, neutral and ground can be ordered separately and shipped unassembled

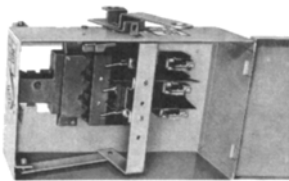

Fusible TAP

Special Industry Fusible Plug-In Units

- Special industry plugs are I²t rated
- Knockouts are not provided
- Grounding lug included on 200A and above
- Lugs ordered and shipped separately
- Fuses are not included
- If neutral or ground assembly is required, contact your local Eaton Field Sales office

Fusible Switch Horsepower Ratings

Ampere Rating	240V		480V		600V	
	NEC® Standard	Time Delay	NEC Standard	Time Delay	NEC Standard	Time Delay
30	3	7-1/2	5	15	7-1/2	20
60	7-1/2	15	15	30	15	50
100	15	30	25	60	30	75
200	25	60	50	125	60	150
400	50	100	100	250	125	350
600	75	100	200	400	200	500

Fusible Plug-In Units ①

Ampere Rating	600V Catalog Number	240V Catalog Number	Neutral (If Required)		Ground (If Required) Catalog Number	Class R Fuse Clips (If Required)	
			Standard Plug-In Catalog Number	Low Impedance Catalog Number		600V Catalog Number	240V Catalog Number
30	TAP361 ②	TAP321 ②	N110 ②	ZN110 ②	GS104 ①②	RFK161 ②	RFK121 ②
60	TAP362 ②	TAP322 ②	N110 ②	ZN110 ②	GS104 ①②	RFK262 ②	RFK222 ②
100	TAP363 ②	TAP323 ②	N110 ②	ZN110 ②	GS104 ①②	RFK464 ②	RFK464 ②
200	TAP364 ②	TAP324 ②	N250KB ②	ZN250KB	GS104 ①②	RFK464 ②	RFK464 ②
400	TAP365	TAP325	N400 ②	②	GS104 ①②	RFK666 ②	RFK666 ②
600	TAP366	TAP326	N400 ②③	ZN400 ②	④	RFK666 ②	RFK666 ②
800	⑤	⑤	—	④	—	—	—

Special Industry Fusible Plug-In Units

Three-Wire, 600V Plug-In Unit		If Required		Terminal Kits for Industry Fusible Plug-In Units					
Ampere Rating	Catalog Number	Neutral Catalog Number	Ground Catalog Number	Mechanical Lugs ②			Compression Lugs ②		
				Catalog Number	Lugs Per Phase	Wire Size	Catalog Number	Lugs Per Phase	Wire Size
30	TAP361H ⑥	⑥	⑥	MTK30SC	1	#14-#4	CTK30SC	1	#12-#10
60	TAP362H ⑥	⑥	⑥	MTK160SC	1	#14-1/0	CTK60SC	1	#8
100	TAP363H ⑥	⑥	⑥	MTK160SC	1	#14-1/0	CTK100SC	1	#4
200	TAP364H ⑥	⑥	⑥	MTK200SC	1	#6-350 kcmil	CTK200BSC	1	2/0
400	TAP365H ⑥	⑥	⑥	MTK400DPW	2	#2-4/0	CTK400SPW	1	750 kcmil
600	TAP366H ⑥	⑥	⑥	MTK600DFW	2	500 kcmil	CTK600DPM	2	500 kcmil

Three-Wire—Ground Detector and Neutralizer Plug

Maximum Volts	Catalog Number
600	GND36

Notes

- ① Not available for low impedance bus duct.
- ② Normally available from stock.
- ③ Only half neutral available. For full neutral, use a TAP366BO or TAP326BO unit.
- ④ Must be factory assembled. Order by description on suffix BUS.
- ⑤ Plug-in unit not available. Contact your local Eaton Field Sales office for bolt-on type.
- ⑥ Must be factory assembled. Order by description.

Quick-Assembled Plugs

The Mod Center in Spartanburg, SC, will perform the assembly of the bus plugs in 3 days or less for most orders. Bid Manager™ enables you to “build” the appropriate catalog number. When the order is entered in Bid Manager, it will automatically transfer the order to suffix “QAP.” Please see the following rules for building the assembled catalog number.

Catalog Numbering Selection

Quick-Assembled Plugs—Breaker Unit ^{①②}

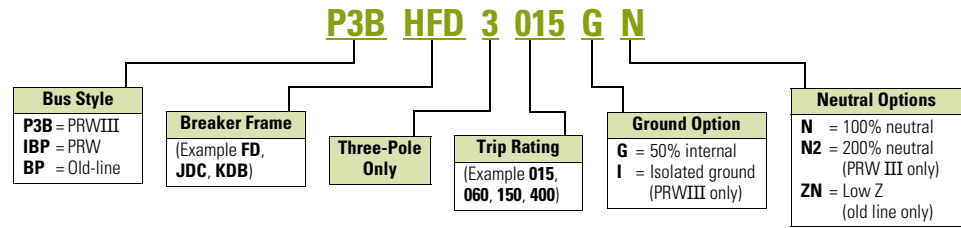

Quick-Assembled Plugs—Fusible Unit ^{②③④}

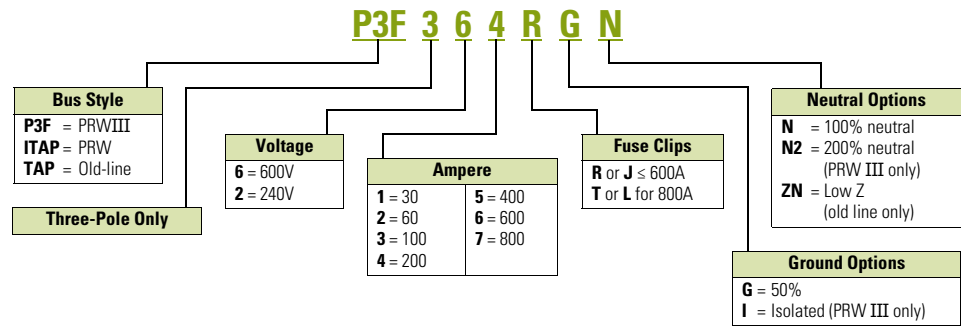

Notes

- ① Do not leave space between characters. Example: **P3BHFD3015GN**.
- ② Contact your local Eaton Field Sales office for help in assigning a catalog number for a specific application.
- ③ Do not leave space between characters. Example: **P3F264RGN**.
- ④ “H” clips are standard for Pow-R-Way and vintage busway products unless specified by adding “R” or “J” in the catalog number. Example: **P3F264RGN**, **ITAP361JGN**.

Replacement Capabilities—CP2, CP3 or CP4 SAFETYBUS Busway Plug-In Units

CP2, CP3 or CP4 SAFETYBUS Busway Plug-In Units

Originally a Westinghouse Product

Bolt-On Units ①

Breaker Frame	Ampere Rating	Enclosure Catalog Number	Neutral ② (If Required) Catalog Number	Ground ③ (If Required) Catalog Number
Circuit Breaker Bolt-On Units (Breaker Not Included)				
EHD, FDB, FD HFD, FDC	15–150	BPFDBO	④	④
JDB, JD, HJD, JDC	125–250	BPJDBO	④	④
KDB, KD, HKD, KDC	250–400	BPKDBO	④	④
LDB, LD, HLD LDC	300–600	BPLDBO	④	④
MDL, HMDL	400–800	BPMDBO	④	④
FB (TRI-PAC)	15–100	BPFBPBO	④	④
LA (TRI-PAC)	125–400	BPLAPBO	④	④
NB (TRI-PAC)	500–800	BPNBPBO	④	④
Fusible Bolt-On Units ⑤				
240V	30	TAP321BO	④	④
	60	TAP322BO	④	④
	100	TAP323BO	④	④
	200	TAP324BO	④	④
	400	TAP325BO	④	④
	600	TAP326BO	④	④
	800	TAP327BO	④	④
600V	30	TAP361BO	④	④
	60	TAP362BO	④	④
	100	TAP363BO	④	④
	200	TAP364BO	④	④
	400	TAP365BO	④	④
	600	TAP366BO	④	④
	800	TAP367BO	④	④

Circuit Breaker Selection and Interrupting Ratings ⑥

Breaker Frame	Ampere Rating	Symmetrical Amperes		
		240 Vac	480 Vac	600 Vac
EHD	15–60	18,000	14,000	—
	70–100	18,000	14,000	—
FDB	15–60	18,000	14,000	14,000
	70–100	18,000	14,000	14,000
	110–150	18,000	14,000	14,000
FD	15–60	65,000	25,000	18,000
	70–100	65,000	25,000	18,000
	110–150	65,000	25,000	18,000
HFD	15–60	100,000	65,000	25,000
	70–100	100,000	65,000	25,000
	110–150	100,000	65,000	25,000
FDC	15–60	200,000	100,000	50,000
	70–100	200,000	100,000	50,000
	110–150	200,000	100,000	50,000
JDB	70–225	65,000	25,000	18,000
	250	65,000	25,000	18,000
JD	70–225	65,000	25,000	18,000
	250	65,000	25,000	18,000
HJD	70–225	100,000	65,000	25,000
	250	100,000	65,000	25,000
JDC	70–225	200,000	100,000	50,000
	250	200,000	100,000	50,000
KDB	250–400	65,000	35,000	25,000
KD	250–400	65,000	35,000	25,000
HKD	250–400	100,000	65,000	35,000
KDC	250–400	200,000	100,000	50,000
LDB	300–600	65,000	45,000	25,000
LD	300–600	65,000	45,000	25,000
HLD	300–600	100,000	65,000	35,000
LDC	300–600	200,000	100,000	50,000
MDL	400–800	65,000	50,000	25,000
HMDL	400–800	100,000	65,000	35,000
NP	400–1200	65,000	50,000	25,000
HND	400–1200	100,000	65,000	35,000
FB (TRI-PAC)	15–100	200,000	200,000	200,000
LA (TRI-PAC)	70–400	200,000	200,000	200,000
	70–400	200,000	200,000	200,000
NB (TRI-PAC)	600–800	200,000	200,000	200,000
	600–800	200,000	150,000	200,000

Notes

- ① Factory assembled. Contact your local Eaton Field Sales office for delivery and order entry information. When ordering, you must specify:
 1. Load left or load right.
 2. Front or rear mounting.
 3. Type of busway to which unit is to be mounted.
- ② Full neutral. For half neutral, contact your local Eaton Field Sales office.
- ③ Not available for low impedance bus duct.
- ④ Order by description with bolt-on unit.
- ⑤ These bolt-on units include an adapter for mounting at the joint. They do not require a power take-off unit.
- ⑥ Refer to the current *Price and Availability Digest (PAD)* for breaker list prices.

Originally a Cutler-Hammer Product

Fusible Switch Plug-In Units

Class R Fuse Clip Included

Ampere Rating	Maximum hp Rating ^①	Catalog Number	Maximum hp Rating ^{①②}	Catalog Number ^③
240V, Three-Phase, Three-Wire			120–208V, Three-Phase, Four-Wire	
30	7-1/2	CP4HD321	5	CP4HD421
60	15	CP4HD322	10	CP4HD422
100	30	CP4HD323	25	CP4HD423
200	60	CP4HD324	60	CP4HD424
400	100	CP4HD325	250	CP4HD425
600 ^④	100	CP4HD326	400	CP4HD426
600V, Three-Phase, Three-Wire			277–480V, Three-Phase, Four-Wire	
30	20	CP4HD361	15	CP4HD461
60	50	CP4HD362	30	CP4HD462
100	75	CP4HD363	60	CP4HD463
200	100	CP4HD364	100	CP4HD464
400	350	CP4HD365	250	CP4HD465
600 ^④	500	CP4HD366	400	CP4HD466

Plug-In Cable Tap Boxes—Plug Into CP2, CP3 or CP4 Busway ^⑤—600A and 800A Sizes Also Have Bolt-On Clips

Approximate Dimensions in Inches

Volts	Ampere Rating	Approximate Dimensions in Inches			Mounting Clearance		Conduit Sizes	Load Lugs Each Phase	Catalog Number
		Wide	High	Deep	Top	Front			
Three-phase, three-wire 600V maximum	225	15.50	8.10	6.90	6.30	10.50	1-1/2, 2, 2-1/2, 3	(1) #6–300 kcmil Al/Cu	CP2SB34
	400	22.30	8.10	7.90	7.00	11.30	1-1/2, 2, 2-1/2, 3	(1) #1/0–750 kcmil Al/Cu ^⑥	CP2SB35
	600	37.20	15.80	11.70	12.50	16.80	1-1/2, 2, 2-1/2, 3	(2) #2–600 kcmil Al/Cu	CP2SB36 ^④
	800	37.20	15.80	11.70	12.50	16.80	1-1/2, 2, 2-1/2, 3	(3) #2–600 kcmil Al/Cu	CP2SB37 ^④
Three-phase, four-wire 120/208V or 277/480V 100% neutral	225	15.50	8.10	6.90	6.30	10.50	1-1/2, 2, 2-1/2, 3	(1) #6–300 kcmil Al/Cu	CP2SB44
	400	22.30	8.10	7.90	7.00	11.30	1-1/2, 2, 2-1/2, 3	(1) #1/0–750 kcmil Al/Cu ^⑥	CP2SB45
	600	37.20	15.80	11.70	12.50	16.80	1-1/2, 2, 2-1/2, 3	(2) #2–600 kcmil Al/Cu	CP2SB46 ^④
	800	37.20	15.80	11.70	12.50	16.80	1-1/2, 2, 2-1/2, 3	(3) #2–600 kcmil Al/Cu	CP2SB47 ^④

Notes

- ① Maximum hp ratings apply when time delay fuses are used.
- ② 120–208V hp ratings are based on 200V motor usage.
- ③ All units ship as three-phase, four-wire plugs.
- ④ Requires two adjacent plug-in outlets that do not span a busway joint.
- ⑤ For ground stab to engage internal ground bus, add suffix “G” to catalog number.
- ⑥ Also accepts (2) #1–300 kcmil Al/Cu.

Replacement Capabilities—CP2, CP3 or CP4 SAFETYBUS Busway Plug-In Units

Originally a Cutler-Hammer Product
Approximate Dimensions

Required Mounting Clearances

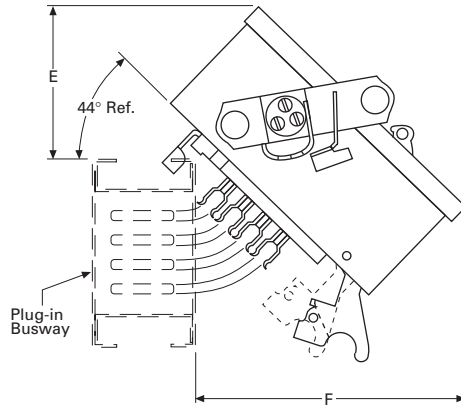

Typical Side and Front

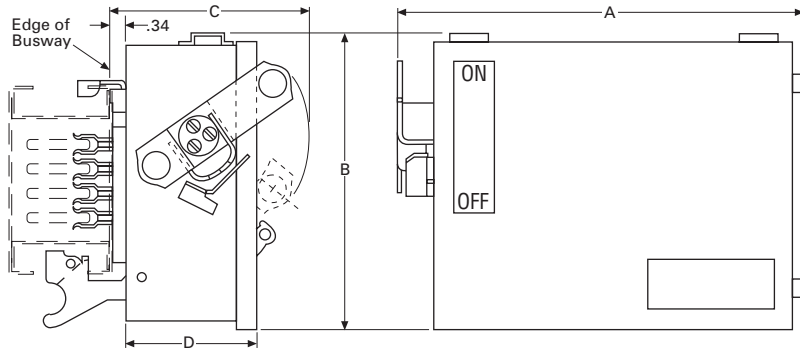

Plug-In Units—May be Used with Either CP2, CP3 or CP4 Plug-In Busway Sections—Fusible Switch Type

9

Frame or Type	Maximum Ampere Rating	Dimensions in Inches						Conduit Sizes Top, Bottom and Side	Wire Size Range Al/Cu
		A	B	C	D	E	F		
CP4HD	30	19.30	11.50	8.80	5.20	7.00	9.00	1/2, 3/4, 1, 1-1/4, 1-1/2, 2	(1) #14-2
	60	19.30	11.50	8.80	5.20	7.00	9.00	1/2, 3/4, 1, 1-1/4, 1-1/2, 2	(1) #14-2
	100	19.30	11.50	8.80	5.20	7.00	9.00	1/2, 3/4, 1, 1-1/4, 1-1/2, 2	(1) #14-1/0
CP4HD	200	23.00	16.50	9.20	6.00	7.50	13.30	1-1/2, 2, 2-1/2, 3	(1) #6-300 kcmil
	400 ^{①②}	45.60	24.30	15.80	13.10	14.00	20.50	1-1/2, 2, 2-1/2, 3	(1) #1/0-300 kcmil or (1) 750 kcmil
	600 ^{①②}	45.60	24.30	15.80	13.10	14.00	20.50	1-1/2, 2, 2-1/2, 3	(2) #2-600 kcmil

Notes

- ① Provided with busway bolt-on clip and straps for 0.50-inch hanger rods.
- ② Unit extends 10.50 inches below busway.

Technology Upgrades

Clipper Power Systems, Busway TVSS Protection

The low voltage busway aftermarket product offering includes transient voltage surge suppression (TVSS), which is ideal for busway fed distribution systems. Eaton has developed the Clipper Power System (CPS) family of products to ensure that the quality power required to maximize productivity in today’s competitive environment is supplied to commercial, industrial, medical and institutional facilities. Without power

protection devices, microprocessors and electronic-based loads are not provided with the noise and disturbance-free power that they require. Because microprocessor-based loads are now common in every facility, engineers must ensure the AC power supply is properly filtered. The CPS busway family of products consists of TVSS and filter components (TVSS filter) integrated into a bus plug with a fusible disconnect. TVSS bus plugs are available for the following types of plug-in busway:

- Westinghouse standard plug-in
- Westinghouse low impedance plug-in
- Westinghouse H5000 plug-in
- Cutler-Hammer CP2 plug-in
- Cutler-Hammer CP3 plug-in
- Cutler-Hammer CP4 plug-in
- Westinghouse Pow-R-Way
- Westinghouse Pow-R-Way II
- Cutler-Hammer Pow-R-Way III

Significant performance advantages are achieved by integrating TVSS filters into busway systems. Because the TVSS unit is directly connected to the busway, the CPS minimizes let-through voltage. This is a significant performance advantage compared to cable-connected TVSS solutions. Due to the integrated design, the CPS bus plug also saves the user wall space and greatly reduces the installed project cost.

Catalog Numbering Selection

Visor Series Bus Plug

P3BCPS 250 480Y S A

Bus Style	
P3BCPS	= Pow-R-Way
TAPCPS	= Std. plug-in
ZTAPCPS	= Low impedance
HTAPCPS	= H5000
CP4CPS	= CP2/CP3/CP4
ITAPCPS	= Pow-R-Way

Surge Rating (kA/Phase)
100 = 100
120 = 120
160 = 160
200 = 200
250 = 250
300 = 300
400 = 400
500 = 500

Voltage Code	Voltage Requirements			
	120/208 240V	230/400 400V	277/480 480V	347/600 600V
Three-phase wye (4W+G)	208Y	400Y	480Y	600Y
Three-phase delta (4W+G)	240D	—	480D	600D

Diagnostics Package	
A = AdVisor	complete with status indicator lights on each phase. Form C. Audible Alarm—Enable/Disable
S = SuperVisor	complete with status indicator lights on each phase, 1-Form C. Audible Alarm—Enable/Disable, Transient Counter, Push-to-Test, PQ Meter (no date stamp)
N = NetVisor	complete with status indicator lights on each phase. Form C. Audible Alarm—Enable/Disable, Transient Counter, Push to Test, PQ Meter (no date stamp), Modbus® and Ethernet Communications Port, % Life Remaining, % Voltage THD

IQ Energy Sentinel for Bus Plugs

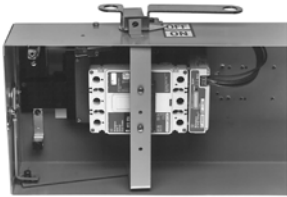

Bus Plug with Energy Sentinel

Customer Required Information

If Originally a Westinghouse Product

1. Style number or shop order number from existing busway nameplate and complete nameplate information.
2. Height and width dimensions of housing from existing busway.
3. Order by style number on suffix Q77.

If Originally a Cutler-Hammer Product

1. Check Vista for pricing.
2. Order by catalog number on suffix Q73.

The Cutler-Hammer IQ Energy Sentinel™ was designed as part of the PowerNet™ system and is a highly accurate, microprocessor-based submeter that monitors power and energy. It offers a centralized alternative to individually mounted wattmeters, watthour meters and watt demand meters.

Key advantages include unmatched savings in space, lower installation costs, and the capability to communicate data readings in a variety of ways. IQ Energy Sentinels with built-in current transformers (CTs) and communications have the added benefit of overall system accuracy. The IQ Energy Sentinel mounts on the load side of Cutler-Hammer F, J and K breakers within the bus-plug enclosure.

The IQ Energy Sentinel is also available with a universal mounting that uses external CTs and is offered for fusible bus plug applications. Sub-metering application examples for the IQ Energy Sentinel include energy monitoring and demand management, energy cost analysis/allocation, and tenant or interdepartmental billing. To accomplish the communications system, the customer must provide a twisted pair communication cable in 1/2-inch conduit between the IQ Energy Sentinel bus plug and a Cutler-Hammer Central Energy Display, or customer computer to display the information. IQ Energy Sentinel bus plugs are available for Pow-R-Way, Pow-R-Way II and Pow-R-Way III busway.

Further Information

Publication Number	Description
AD 30-560	Application Data for Pow-R-Way
AD 30-560	Application Data for Pow-R-Way II
TD01701001E	Technical Data for Pow-R-Way III
TD01701002E	Technical Data for 100 Ampere Busway

Pricing Information

Vista/VISTALINE™ Discount Symbols CE3 and CE4

Note: Contact your local Eaton Field Sales office.

Note: Additional information may be required for manufacturing.